

# WAITINGTRAY

**COMPACT, VERSATILE, INDISPENSABLE**



**rational**  
PRODUCTION

**rational**  
PRODUCTION

85.0°C

30°

MAXIMUM EXTRA



# WAITINGTRAY PERFORMANCE

**WAITINGTRAY** is the module designed to keep meals at the correct serving temperature for patients who are absent from their room at the time of distribution.

Due its compact design, up to 4 trays can easily be stored in the service room of each ward.

The trays for patients that are absent from their ward are simply taken out of UNITRAY or PROSERV distribution trolleys and placed in WAITINGTRAY.

This ensures that all meals are served at the optimum quality and that the distribution trolleys are not held up waiting for patients to return to the ward.

**WAITINGTRAY** is the ideal complementary unit for the UNITRAY and DSPRO SYSTEM.

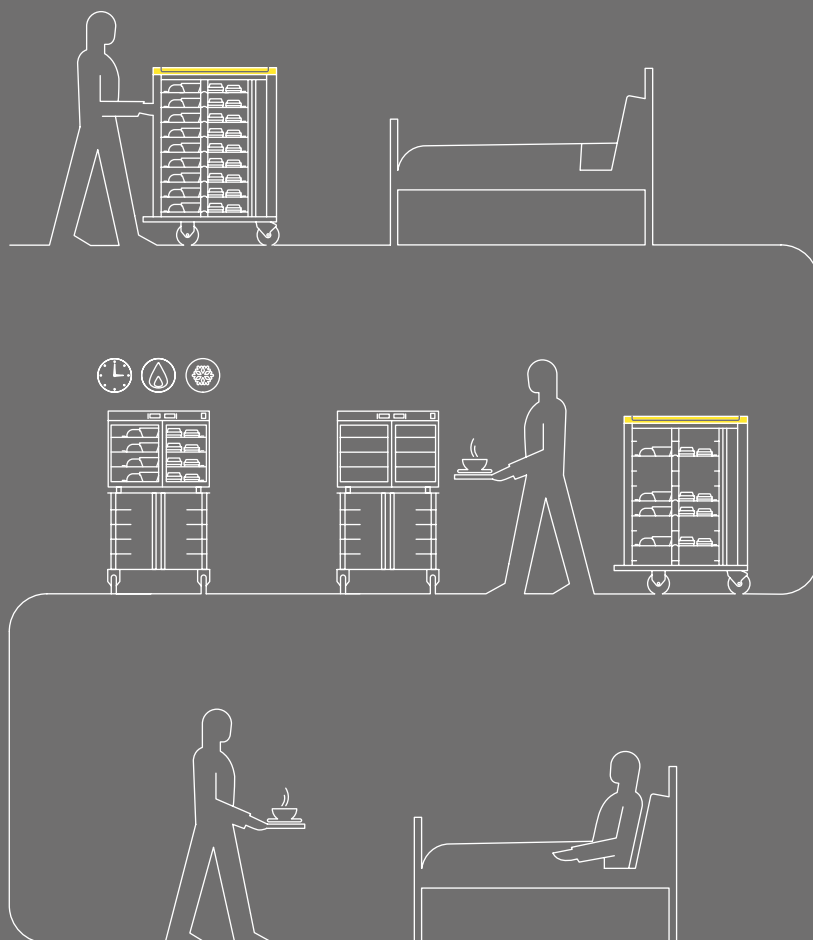

# WAITINGTRAY SPECIFICATIONS

**WAITINGTRAY** ensures meals are served at the optimum temperature when patients return to their ward. Distinguishing features:



## STRENGTH

- ROBUST DOORS
- INTEGRATED HINGES
- ALUMINIUM SHELL
- TEMPERED GLASS



## DESIGN

- COMPACT SIZE
- INTEGRATED THERMOREGULATORS
- CURVED INTERNAL CORNERS FOR EASY CLEANING



## COMPATIBILITY

Compatible with the whole range of Rational Production trays

## GASTRONORM

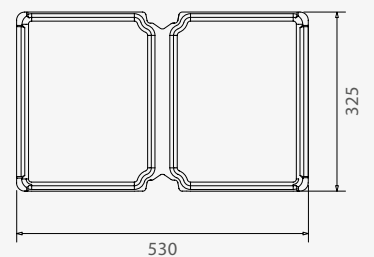



### PRECISION

Food kept at exactly the set temperatures



### RELIABILITY

Silicone seals for increased thermal insulation



### SAFETY

Digital temperature control and display

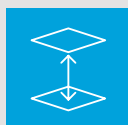

### PRACTICALITY

A pitch of 91.15 MM between the trays for ease of use

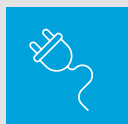

### SIMPLICITY

Plugs into single phase supply



### STACKABILITY

It is possible to stack two modules one on top of the other

GASTRONORM 63-37

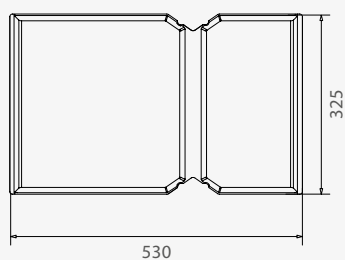

GASTRONORM FLAT

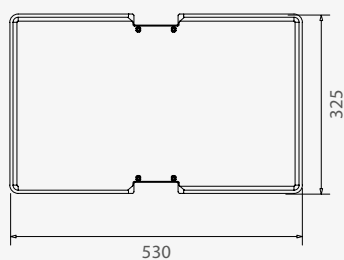

EURONORM

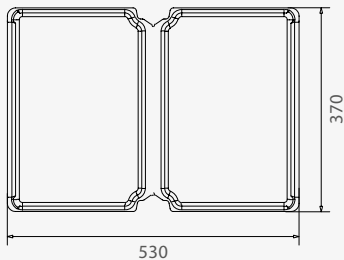

EXTENDED

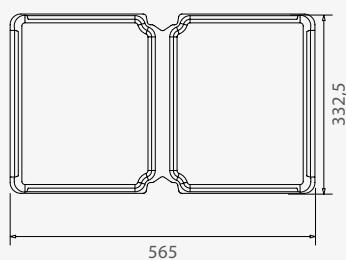

# WAITINGTRAY SPECIFICATIONS



POWER	CONSUMPTION
220 - 230 V	500 W

## TEMPERATURE

Temperatures can be set from 3°C for the cold section to 85°C for the warm section.

## STACKABILITY

Two WAITINGTRAY modules can be stacked one on top of the other hence doubling the capacity in wards with a high number of patients or with special requirements.

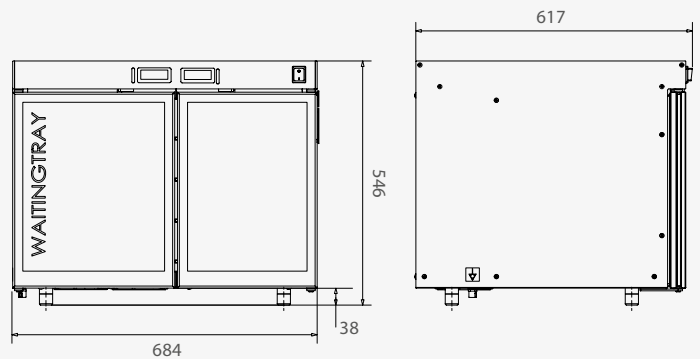

# WAITINGTRAY ACCESSORIES



## DEPARTMENT ID

A highly useful stainless steel accessory that allows the user to identify the ward assigned to each WAITINGTRAY.



## HANDLING TROLLEY

A useful alternative allows WAITINGTRAY to be transferred between wards. This practical trolley is made of aluminium and thick HPL panels and it is equipped with 4 x 125 mm diameter heavy duty swivel wheels, 2 of which with built-in brakes.

There are two versions available, with or without tray holders, to meet all possible demands.

## TECHNICAL SPECIFICATIONS

WAITINGTRAY		
DESCRIPTION	UNIT OF MEASURE	VALUE
Dimensions	mm	684 x 617 x 546 h
Protection grade		IPX4
Cold compartment min. temperature	°C	3
Hot compartment max. temperature	°C	85
Tray capacity	n.	4
Tray pitch	mm	91,15
Tray type		GN, GN FLAT, GN 63-37, EN, EXTENDED
Work environment temperature	°C	da 5°C a 32°C
Coolant gas		R134a

### ELECTRICAL STANDARDS

230V 16A 1F+N+T

### PRODUCT DESCRIPTION

Application	Ward thermal maintenance module for thermo-refrigerated trays.
Exterior	Case: end piece profiles in aluminium treated with a thick anodic oxidation coating, upper and lower end pieces in HPL and anodised aluminium side panels. Doors: 2 with an opening angle of 180°.
Interior	Chamber: in stainless steel with wide folding range for easy cleaning. Tray holders: in easy clean stainless steel. Dividing walls: in plastic material with gaskets replaceable without the use of any tools.
Doors	Consisting of a thick oxidised aluminium frame and tempered glass. Easily removable silicone gaskets. Opening angle 180° . Automatic closure with built-in mechanism to avoid shocks and breakdowns.
Accessories	Transfer trolley made of HPL surfaces and anodised aluminium body columns, equipped with wheels for ease of movement.
Materials	Aluminium, tempered glass, HPL, synthetic material.

# rational PRODUCTION

## RATIONAL PRODUCTION srl

---

Via L. Galvani, 7/H  
24061 Albano S. Alessandro (BG) Italy  
T. +39 035.452.1203  
F. +39 035.452.1983  
info@rationalproduction.com  
**www.rationalproduction.com**